

## ATLAS MDT mezzanine card installation notes

- Card handling
- Cable types
- Card address locations

Card handling :

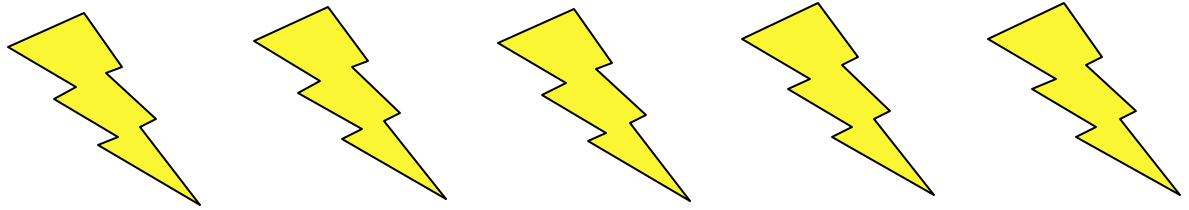

- MDT-ASD mezz cards are static sensitive and can be damaged by human body electrostatic discharges
- Simple remedy
  - Always carry cards in anti-static bags
  - Always use anti-static wrist-strap clipped to local ground when handling cards
  - Clip anti-static wrist-strap to chamber when installing cards

“Normal” mounting convention for cable orientations and card addressing

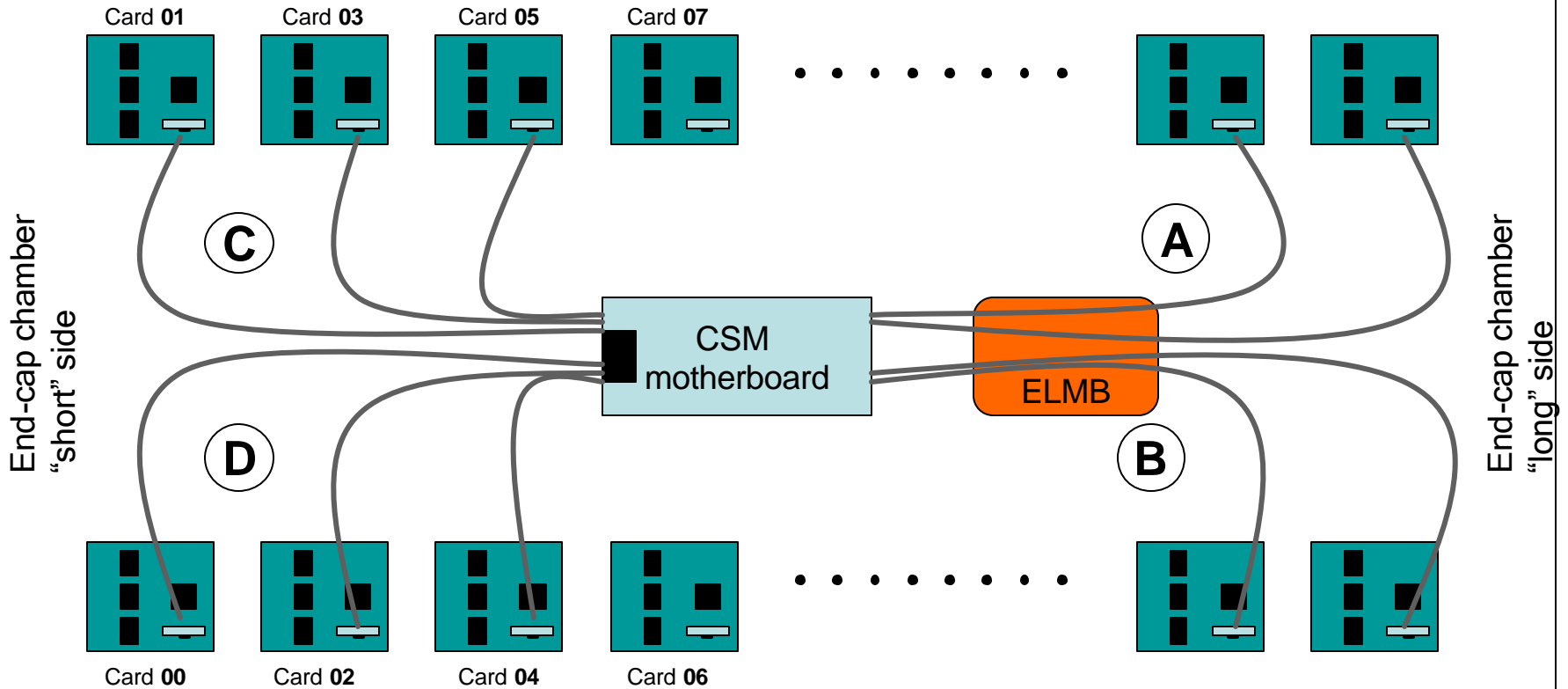

Notes

- Cable ground tab is always at the mezz card end and is attached to faraday cage
- CSM mother board, and Card Addresses shown with power connector to the left
- If CSM mother board is mounted with power cable to the right, then interchange the cable types; A ↔ C & B ↔ D This will result in Card 00 at upper right and Card 01 at lower right.

Orientation - A

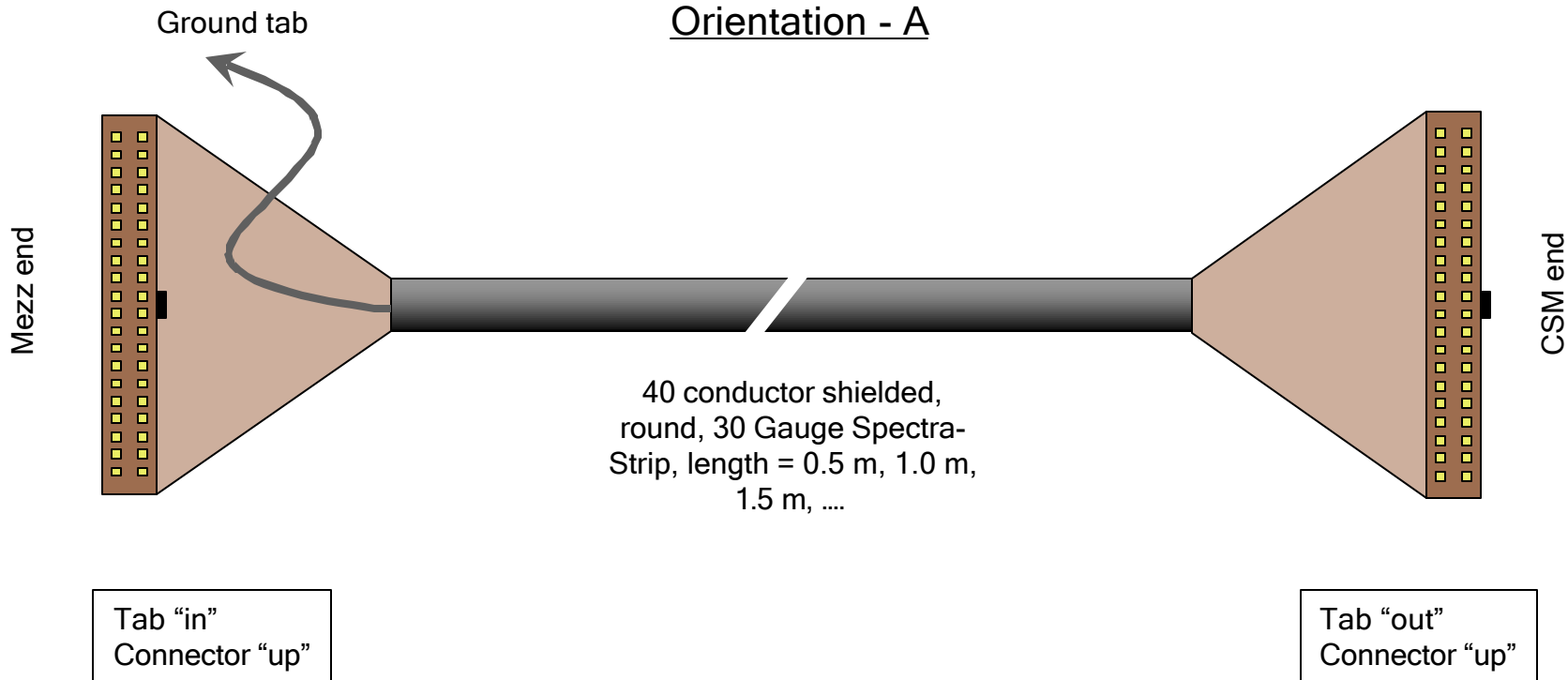

Orientation - B

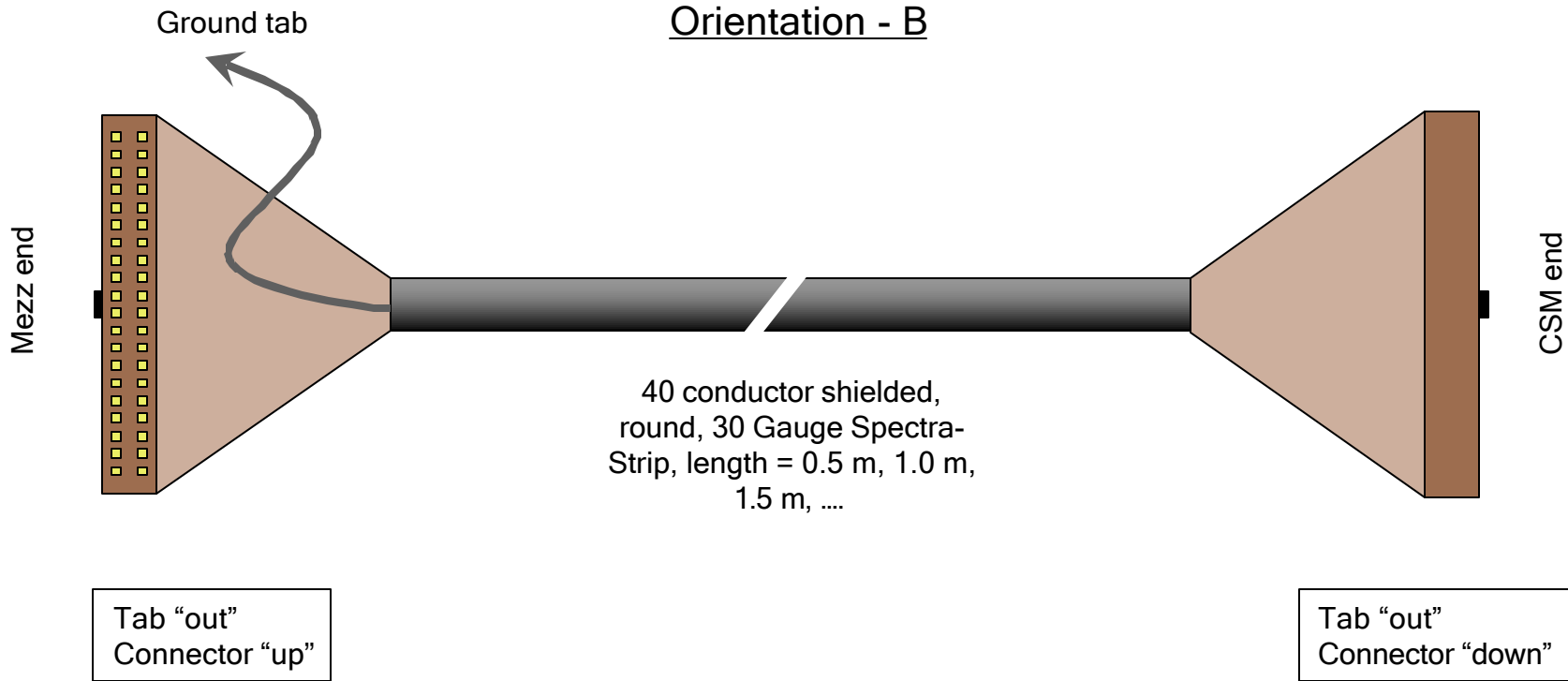

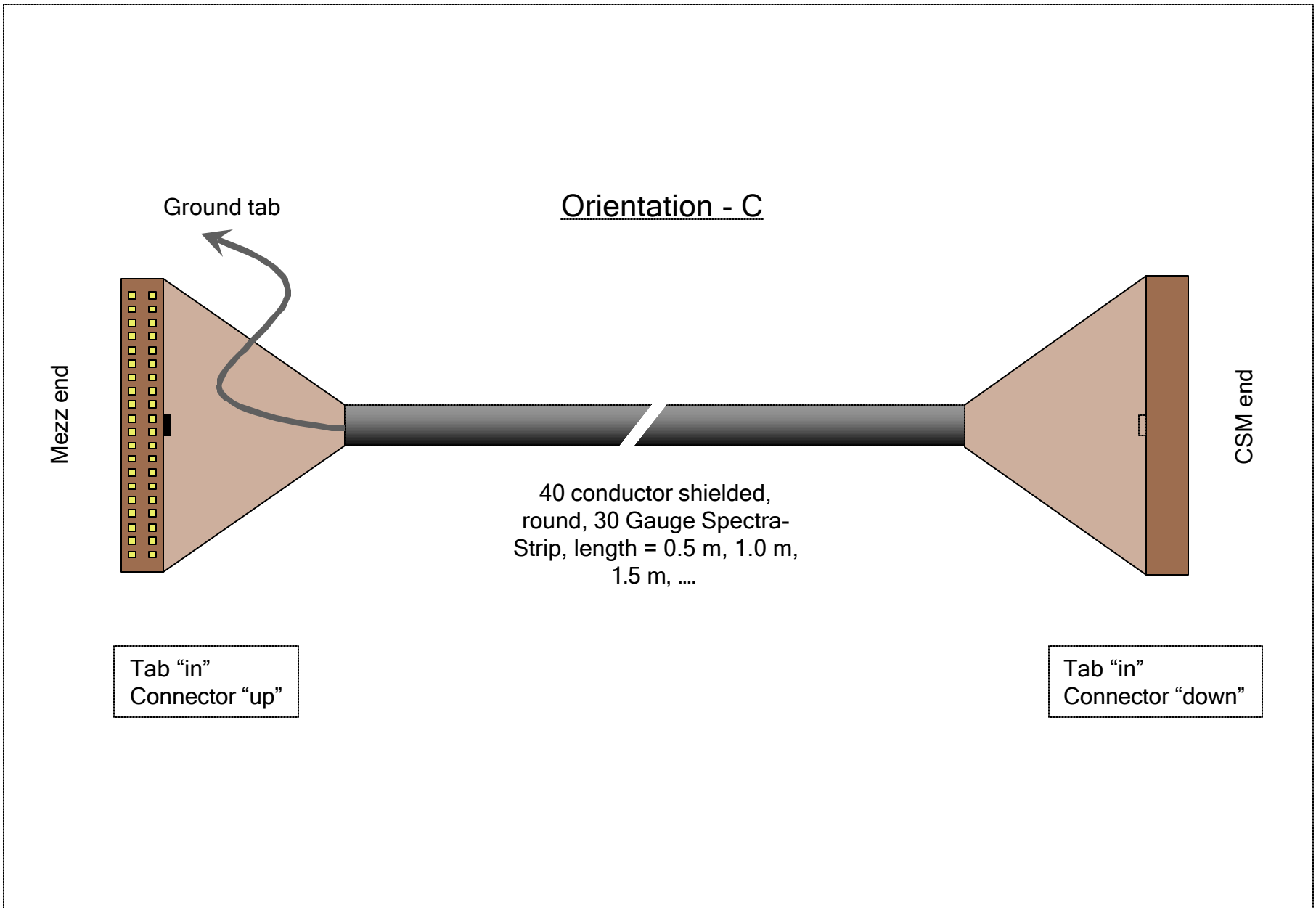

Orientation - D

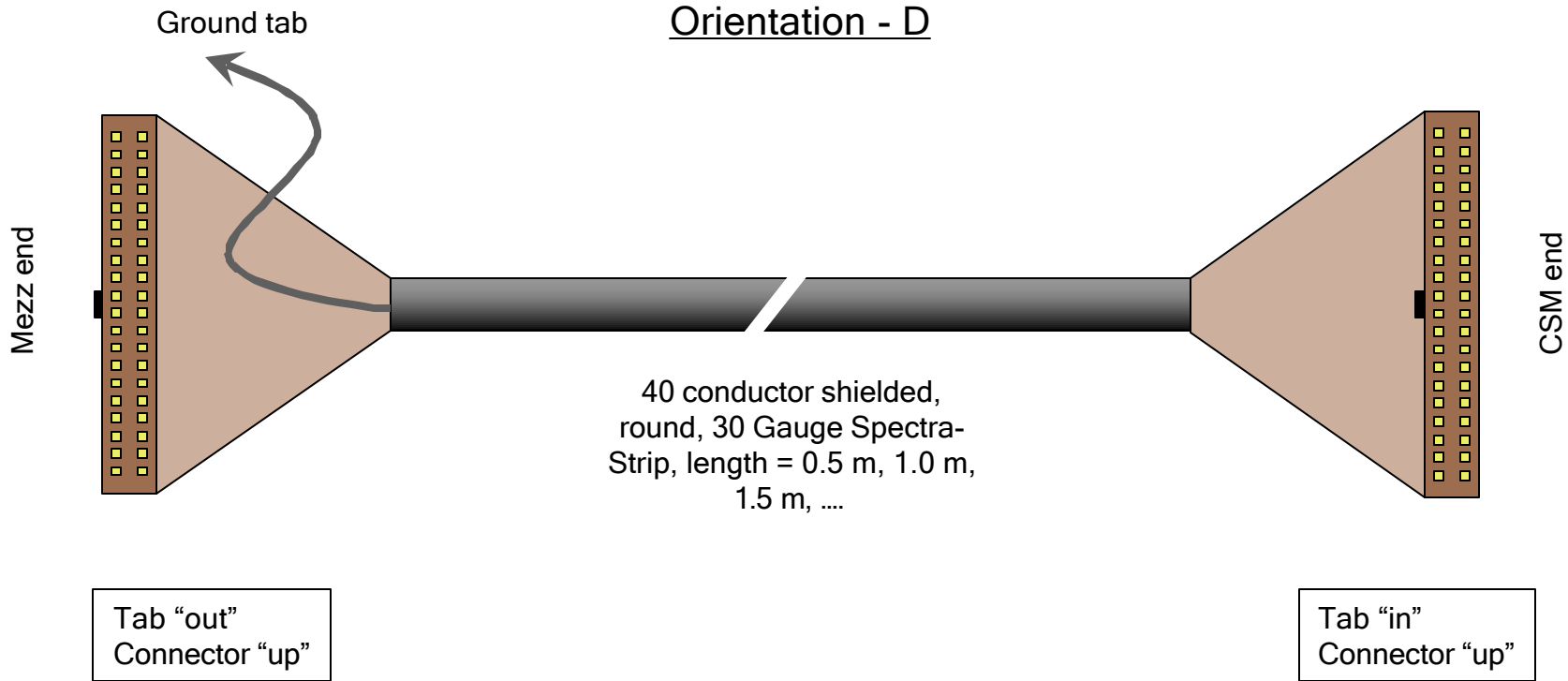

## Cabling detail of EMS-2

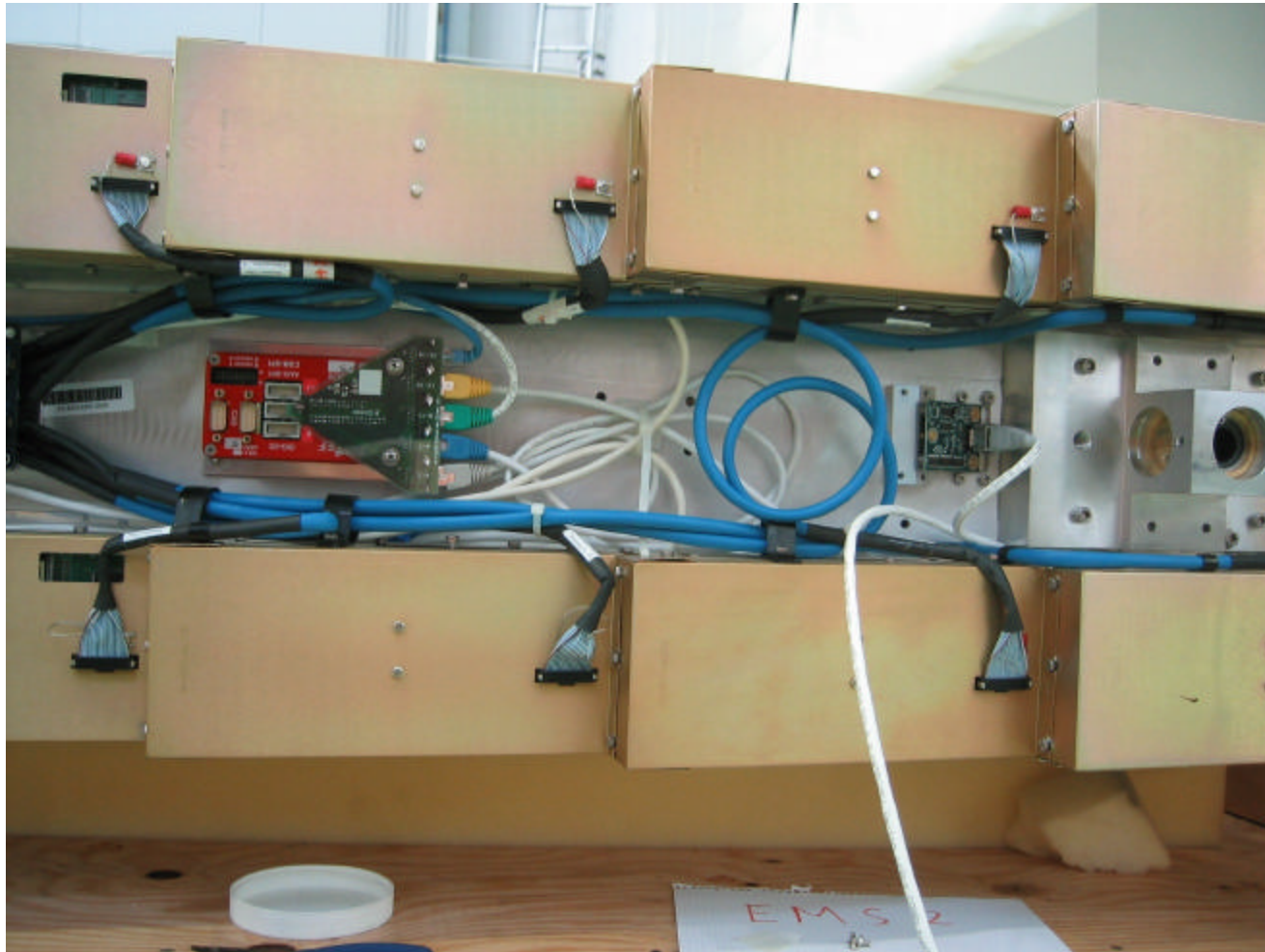

15 April 2003